

A	B	C	D
1	S406-4007	293	60
2	S416-0004	1746	496
3	S416-1004	1706	349
4	S416-1005	1706	349
5	S416-1006	1706	349
6	S416-2003	1200	350
7	S416-2004	1200	350
8	S416-3005	434	331
9	S416-3006	713	331
10	S416-3011	433	331
11	S416-4001	1180	60
12	S416-4003	1706	434

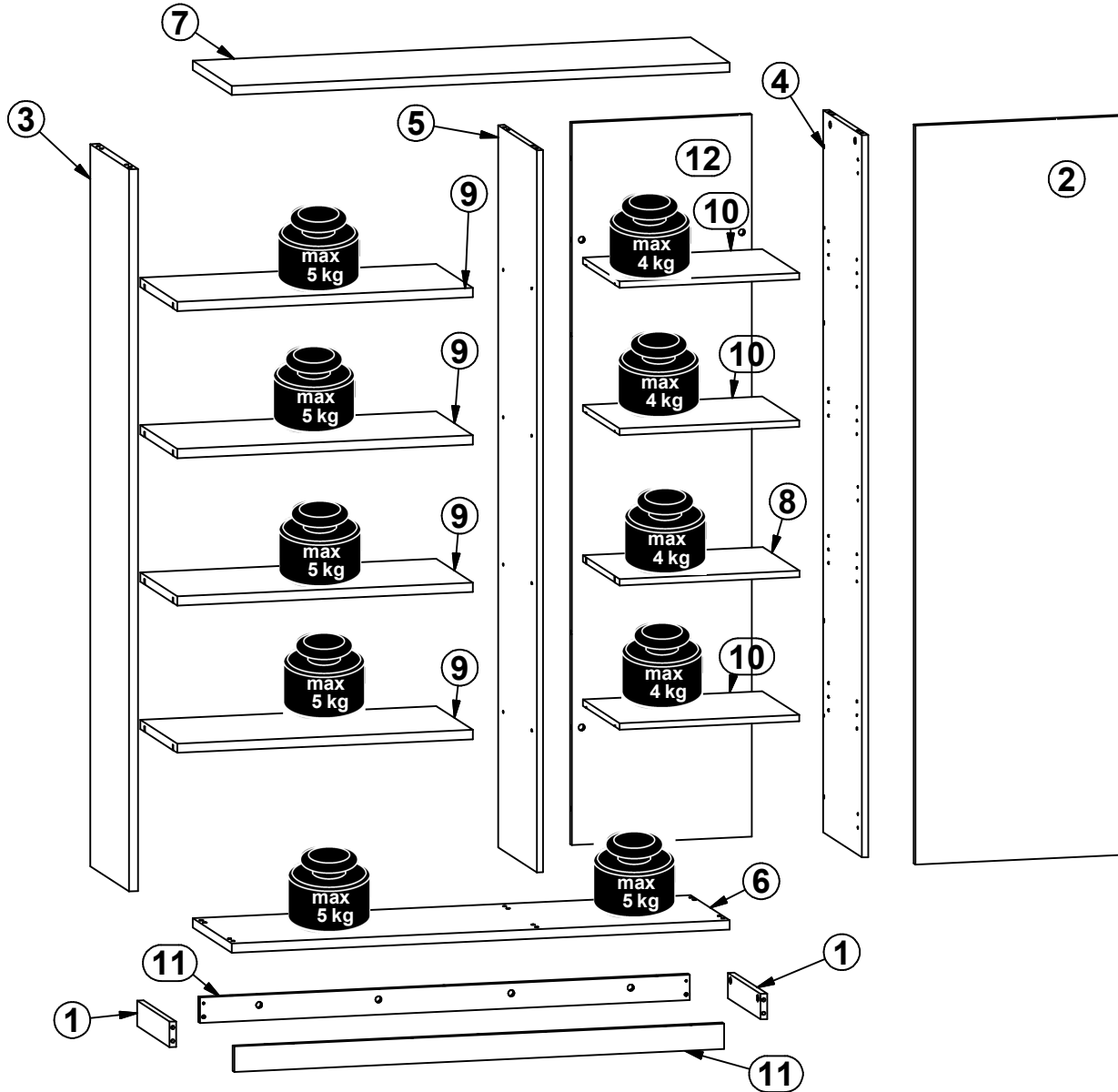

1x  a133	3x  a158	3x  b43	12x  d1 ∅5x17 mm	6x  e2 ∅6.3x13 mm	6x  e8 ∅7x60 mm	30x  f1 ∅8x30 mm	6x  k1	6x  p51 ∅3.5x15 mm
22x  r1 ∅15x12 mm #16	20x  r37 6,7/7,8	22x  r42 20/11	20x  r50	10x  s68 ∅ 20mm	1x  z1 4 mm	1x  n26	1x  p38 ∅3.5x16 mm	

1 

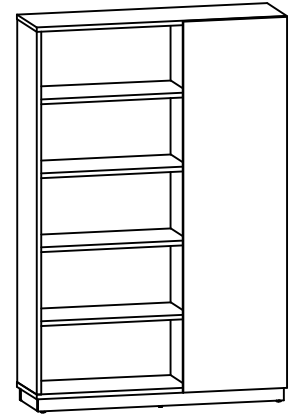
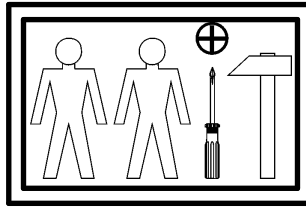
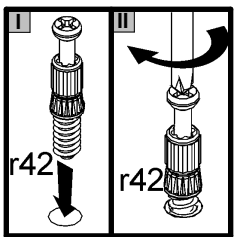
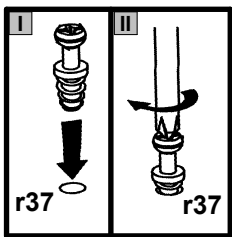
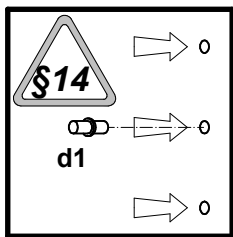
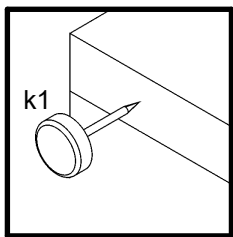
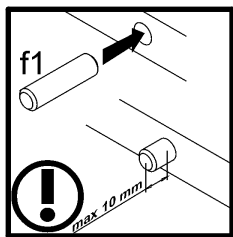
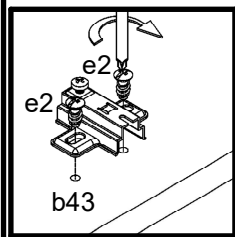
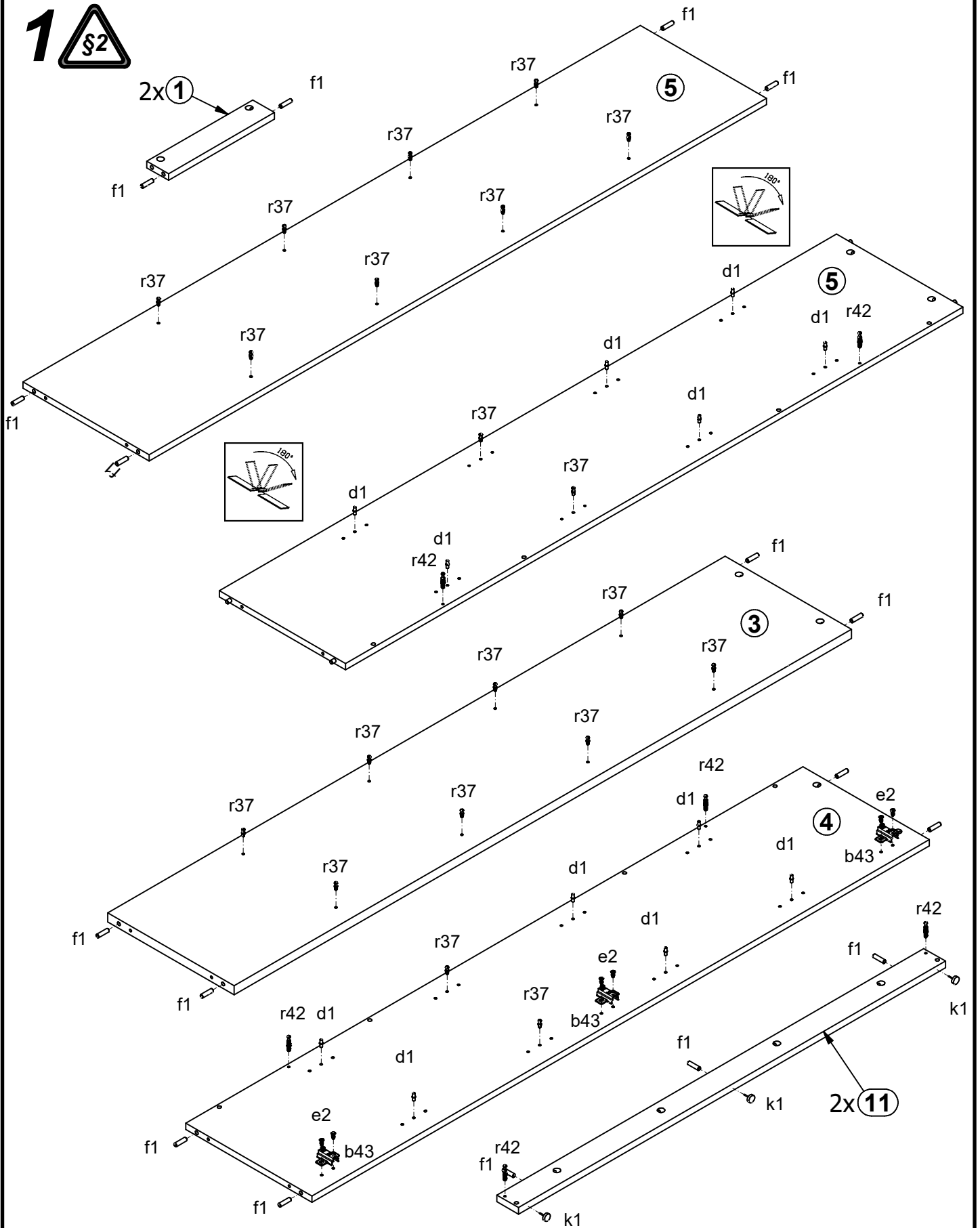

# 2

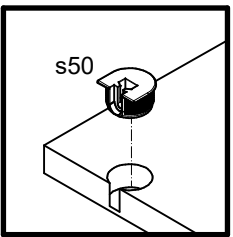
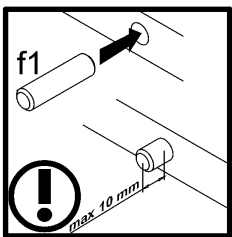
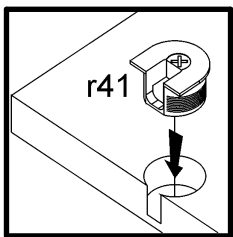
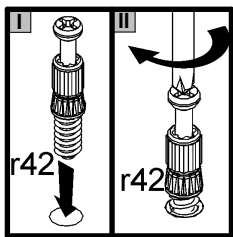
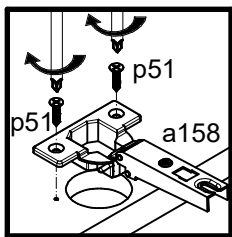
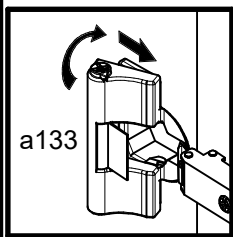
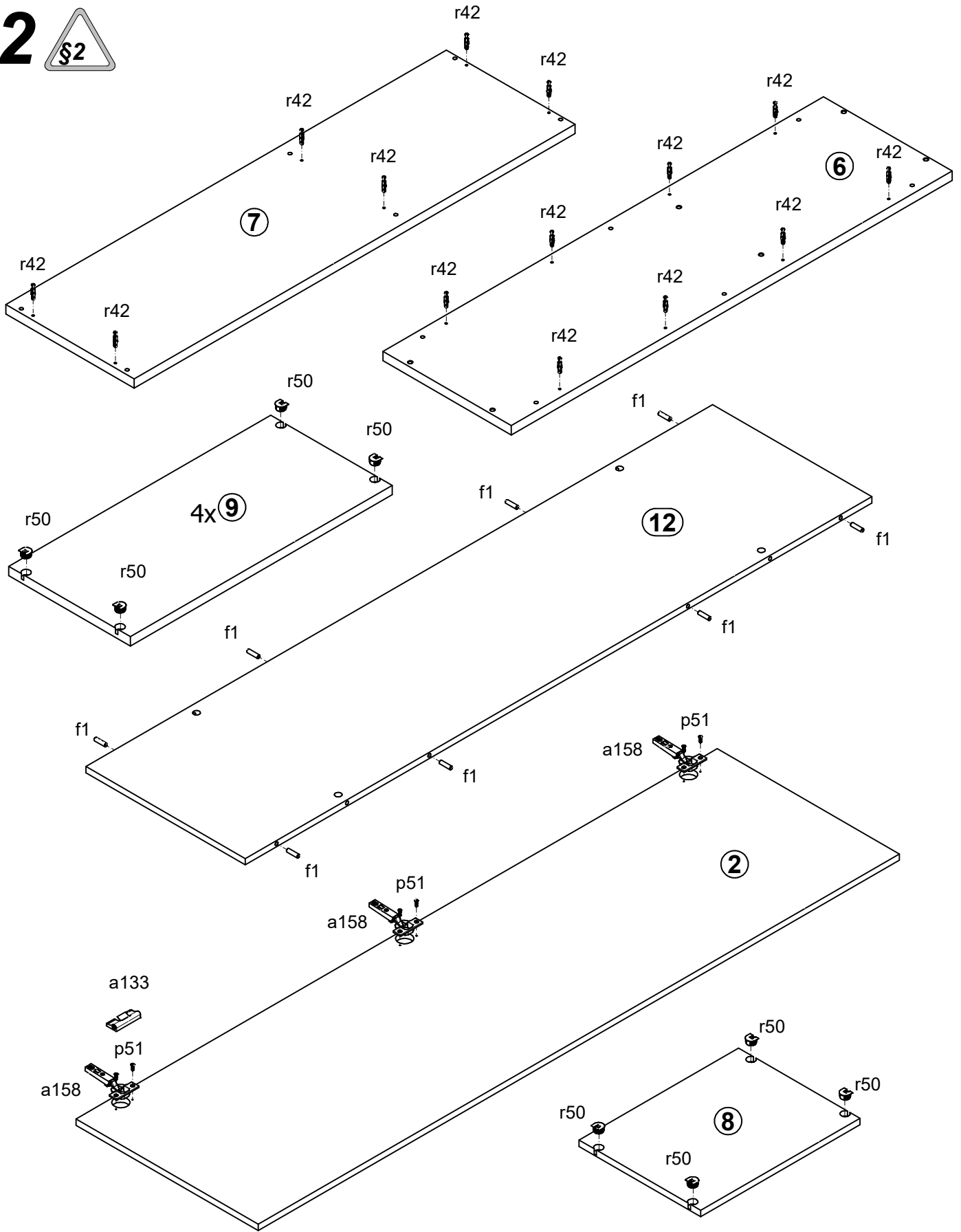

# 3

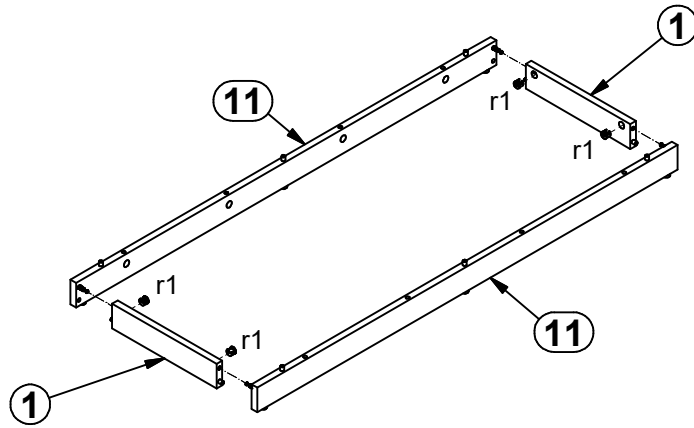

# 4

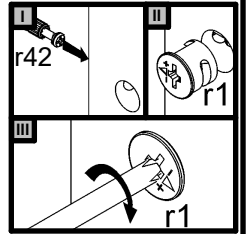
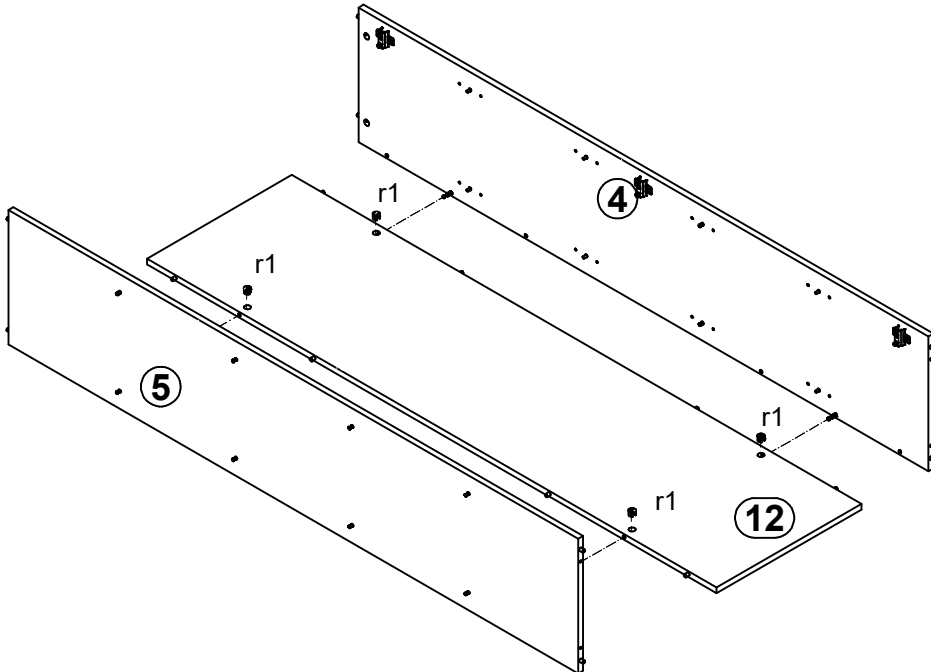

# 5

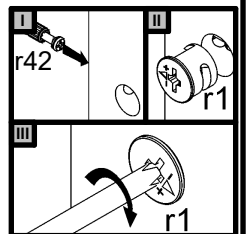
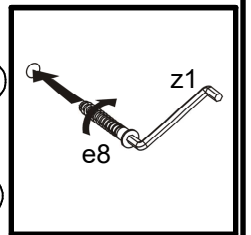
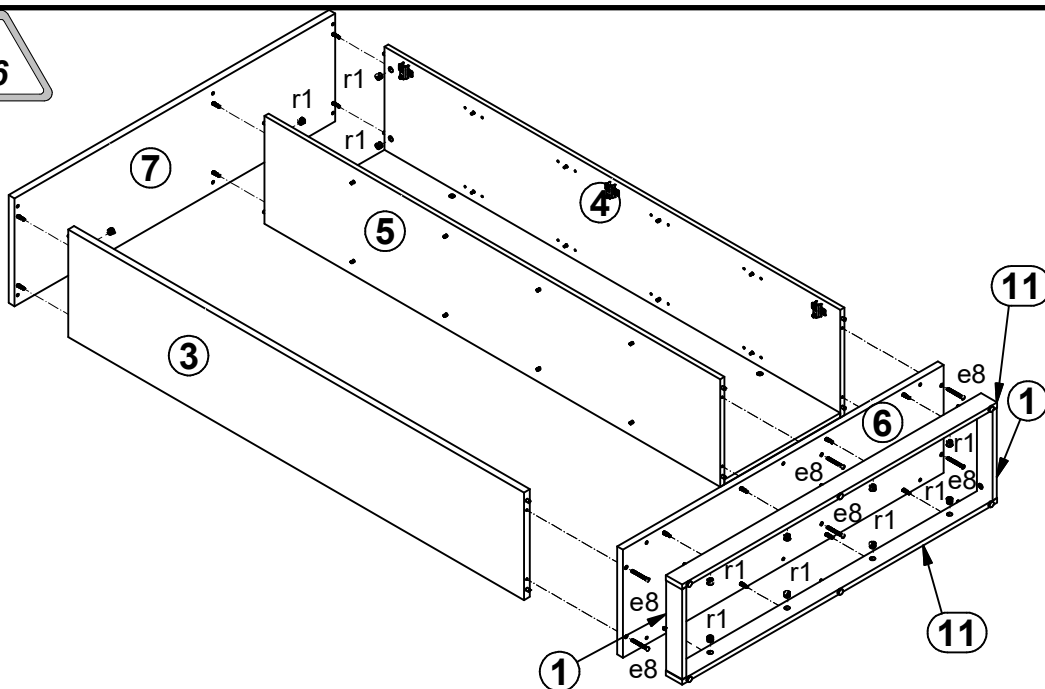

# 6

